

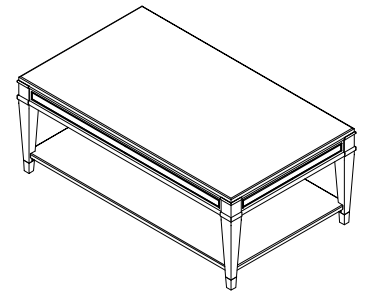







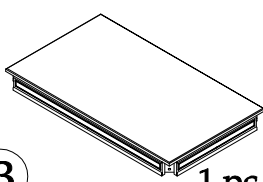
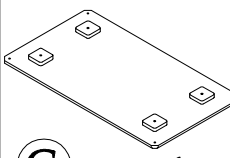
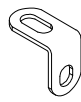
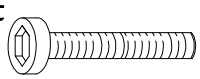

Components and Hardware List

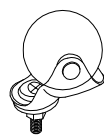

#37002
Rectangle Cocktail Table

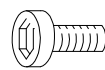
<p>Leg</p>  <p>A 4 pcs.</p>	<p>Table Top</p>  <p>B 1 pc.</p>	<p>Shelf</p>  <p>C 1 pc.</p>	<p>L-Bracket</p>  <p>D 4 pcs.</p>	
<p>M5/16"-18 x 2-1/2" Long Allen Head Bolt</p>  <p>E 8 pcs.</p>	<p>5/16" Spring Washer</p>  <p>F 8 pcs.</p>	<p>5/16" *19*2mm Flat Washer</p>  <p>G 8 pcs.</p>	<p>5mm Allen Wrench</p>  <p>H 1 pc.</p>	<p>Caster</p>  <p>I 4 pcs.</p>
<p>16mm Open Wrench</p>  <p>J 1 pc.</p>	<p>M1/4"-20 x 5/8" Allen Head Bolt</p>  <p>K 8 pcs.</p>	<p>1/4" Spring Washer</p>  <p>M 8 pcs.</p>	<p>1/4" *16*2mm Flat Washer</p>  <p>N 8 pcs.</p>	<p>4mm Allen Wrench</p>  <p>L 1 pc.</p>

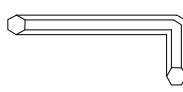
Be sure to check all packing material carefully for small parts, which may have come loose inside the carton during shipment.

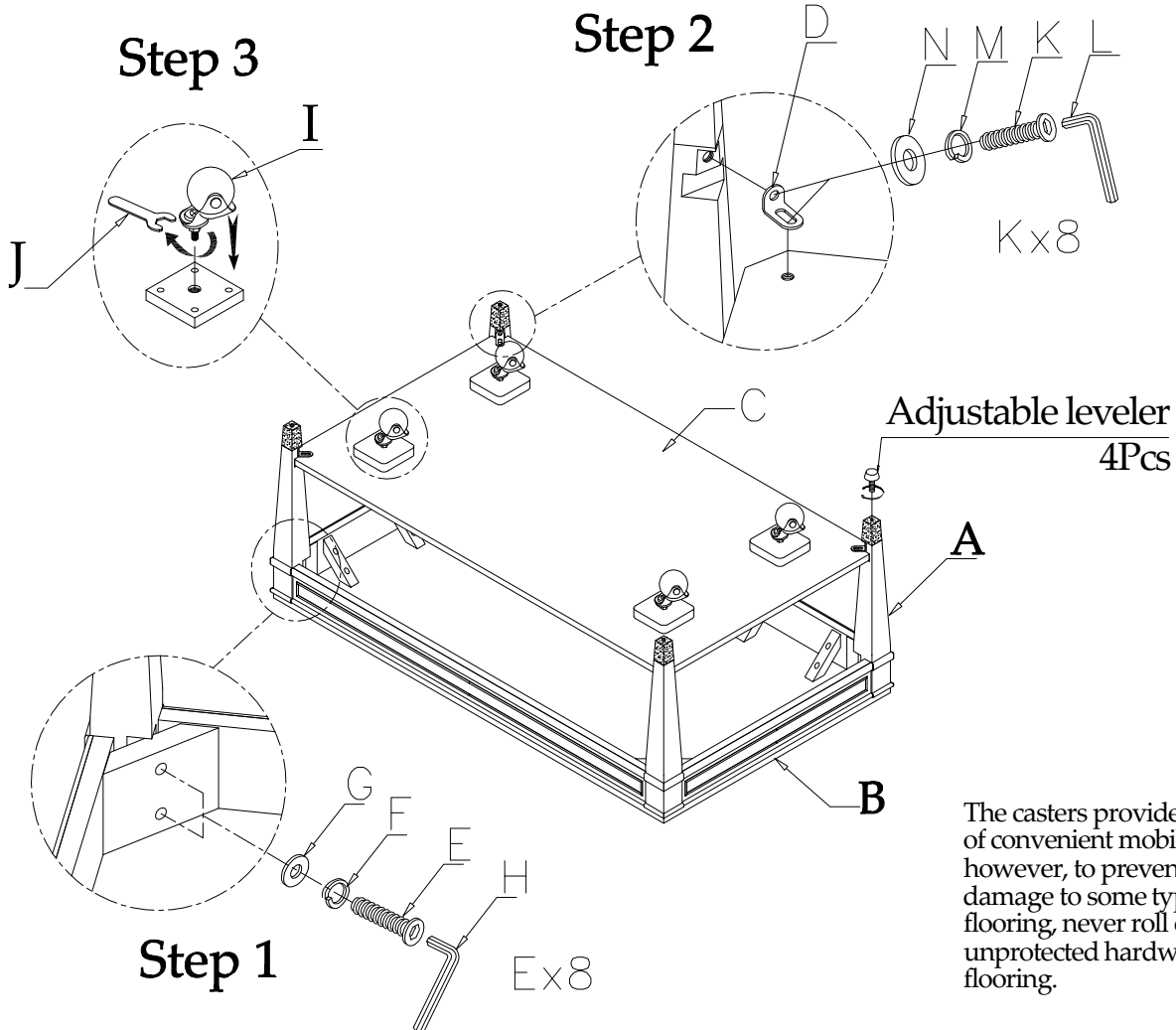

The casters provide an element of convenient mobility, however, to prevent possible damage to some types of flooring, never roll casters on unprotected hardwood or vinyl flooring.